

Composite dry sliding bushings, metric dimensions

Principal dimensions			Basic load ratings		Mass	Designation
d	D	B	dynamic C	static C0	kg	-
mm			kN			
<b>120</b>	125	60	560	1760	0,43	PCM 12012560 E

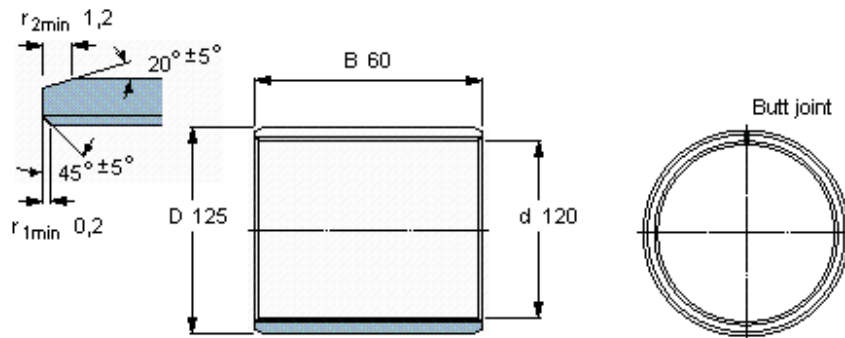

**Specific load factor** K 80  
**Material constant**  $K_M$  480